



COMPRESSION

BRASS COMPRESSION FITTINGS FOR COPPER PIPE

APPLICATIONS

Installations covering the distribution of hot and cold water, heating systems, solar thermal as well as numerous other industrial applications mainly involving the use of copper tubing and brass compression fittings.

INSTALLATION INSTRUCTIONS

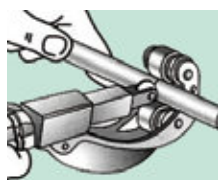

1
CUT
Cut the tube square with a tube cutter and re-round.



2
DE-BURR AND CLEAN
De-burr and clean the end of the tube using steel wool. The interior surface of the fitting must be perfectly clean.

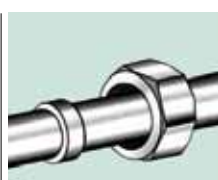

3
PLACE
Place the nut and the olive onto the tube (fitting is disassembled).



4
PUSH
Push the tube into the assembled fitting until it reaches the tube stop.

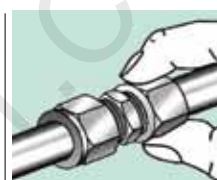

5
SCREW
Push the tube into the fitting body until it reaches the tube stop. Bring the nut and olive to the body and hand tighten.



6
TIGHTEN
Tighten the nut onto the body using a suitable spanner in accordance with the requested torque valves.

MAXIMUM WORKING TEMPERATURE AND PRESSURE

°C	BAR
30	16
65	10
110	6
120	5

UNI EN 1254-2

INDICATIVE TRACTION TURNS INSTRUCTIONS FOR COMPRESSION FITTINGS

DIAMETER	TRACTION TURNS
8 mm	1 1/2
10 mm	1 1/2
12 mm	1 1/2
15 mm	1
18 mm	1
22 mm	1
28 mm	3/4
35 mm	3/4
42 mm	3/4
54 mm	3/4

DIMENSIONS

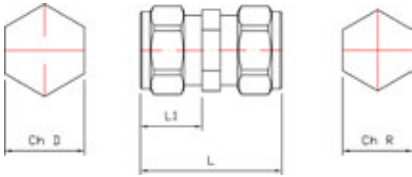

Size mm	L	L1	Ch D	Ch R	Code
10 mm	40	17,5	19	17	82.01.335
12 mm	40	17,5	19	17	82.01.340
15 mm	42,5	18,5	24	21	82.01.010
22 mm	47,5	21	32	29	82.01.110
28 mm	51,5	22	38	36	82.01.210

82.01



STRAIGHT COUPLER C x C

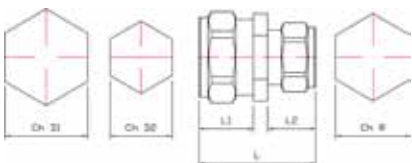

Size mm	L	L1	L2	Ch D1	Ch D2	Ch R	Code
12x10	40	17,5	17,5	19	19	17	82.01.355
15x10	41	18	17,5	24	19	21	82.01.320
15x12	41	18	17,5	24	19	21	82.01.325
22x15	45	21	18,5	32	24	29	82.01.310
28x22	51,5	23	22,5	38	32	36	82.01.330

82.01



STRAIGHT REDUCING COUPLER C x C



Size mm	L	L1	Ch D	Ch R	R	Code
10 mm x 3/8"	35	17,5	19	17	3/8	85.10.030
10 mm x 1/2"	37,5	17,5	19	21	1/2	85.10.035
12 mm x 3/8"	35	17,5	19	17	3/8	85.10.045
12 mm x 1/2"	37,5	17,5	19	21	1/2	85.10.050
15 mm x 3/8"	36,5	18,5	24	21	3/8	85.10.065
15 mm x 1/2"	38	18,5	24	21	1/2	85.10.070
15 mm x 3/4"	43,5	18	24	27	3/4	85.10.075
22 mm x 1/2"	44,5	20,5	32	29	1/2	85.10.090
22 mm x 3/4"	46	20,5	32	29	3/4	85.10.095
22 mm x 1"	50,5	22	32	36	1	85.10.100
28 mm x 1"	51	23	38	36	1	85.10.110

85.10



STRAIGHT ADAPTOR C x MI TAPER THREAD - ISO 7/2



Size mm	L	L1	Ch D	Ch R	F	Code
10 mm x 1/4"	29	16,5	19	17	1/4	82.03.003
12 mm x 3/8"	35	17,5	19	25	3/8	82.03.008
12 mm x 1/2"	35	17,5	19	25	1/2	82.03.009
15 mm x 3/8"	34	18,5	24	21	3/8	82.03.010
15 mm x 1/2"	37	20	24	25	1/2	82.03.012
15 mm x 3/4"	41	20	24	31	3/4	82.03.312
22 mm x 1/2"	39	18	32	25	1/2	82.03.512
22 mm x 3/4"	42	22	32	31	3/4	82.03.112
22 mm x 1"	44	22,5	32	38	1	82.03.412
28 mm x 1"	47	24,5	38	38	1	82.03.212

82.03



STRAIGHT ADAPTOR C x FI

DIMENSIONS

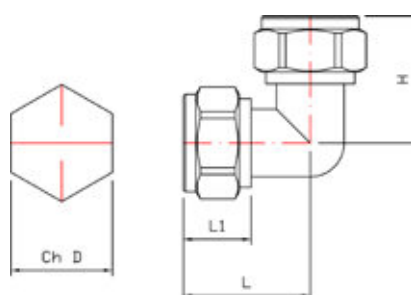

Size mm	L	H	L1	Ch D	Code
10 mm	27,5	27,5	16,5	19	83.01.515
12 mm	27,5	27,5	16,5	19	83.01.615
15 mm	30	30	16	24	83.01.015
22 mm	36	36	18	32	83.01.115
28 mm	41,5	41,5	20	38	83.01.215

83.01



ELBOW C x C

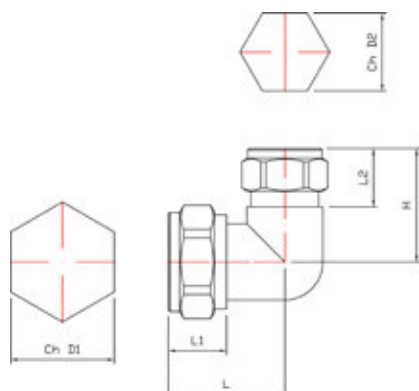

Size mm	L	H	L1	L2	Ch D1	Ch D2	Code
12x10	27,5	27,5	16,5	16,5	19	19	83.01.660
15x10	30	29,5	15	17,5	24	19	83.01.620
15x12	30	29,5	15	17,5	24	19	83.01.625
22x15	36	35	18	18	32	24	83.01.315

83.01



REDUCING ELBOW C x C

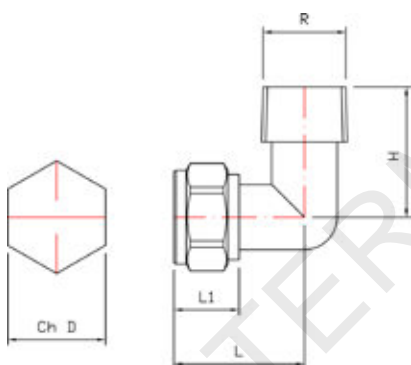

Size mm	L	H	L1	Ch D	R	Code
12 mm x 3/8"	27,5	25	15,5	19	3/8	85.10.165
12 mm x 1/2"	31,5	32	17,5	19	1/2	85.10.170
15 mm x 3/8"	32	28,5	17	24	3/8	85.10.175
15 mm x 1/2"	32	32	17	24	1/2	85.10.180
15 mm x 3/4"	36	38,5	18,5	24	3/4	85.10.185
22 mm x 3/4"	37	38,5	18	32	3/4	85.10.205
22 mm x 1"	41	45	21	32	1	85.10.210
28 mm x 1"	43	45	20	38	1	85.10.220

85.10



ELBOW C x MI TAPER
THREAD ISO 7/2

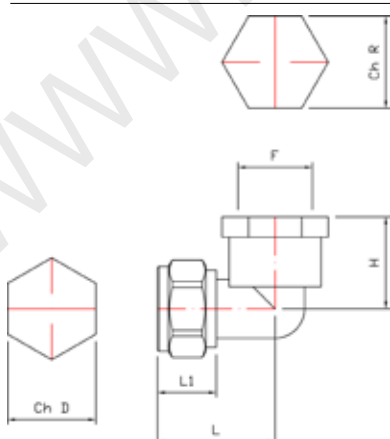

Size mm	L	H	L1	Ch D	Ch Dr	F	Code
12 mm x 3/8"	31,5	24	17,5	19	25	3/8	83.03.535
12 mm x 1/2"	31,5	24	17,5	19	25	1/2	83.03.540
15 mm x 1/2"	32	25	15	24	25	1/2	83.03.017
15 mm x 3/4"	34,5	30	18,5	24	31	3/4	83.03.417
22 mm x 1/2"	35,5	30	18	32	31	1/2	83.03.517
22 mm x 3/4"	35,5	30	18	32	31	3/4	83.03.317
22 mm x 1"	40	35,5	21	32	38	1	83.03.317
28 mm x 1"	41,5	35,5	20	38	38	1	83.03.217

83.03



ELBOW C x FI

DIMENSIONS

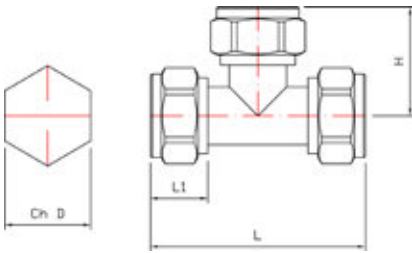

Size mm	L	L1	Ch D	Ch R	Code
10 mm	57	28,5	17,5	19	84.01.418
12 mm	57	28,5	17,5	19	84.01.518
15 mm	60	30	15	24	84.01.018
22 mm	72	36	18	32	84.01.118
28 mm	85,5	42,5	20	38	84.01.218

84.01



EQUAL TEE C x C x C

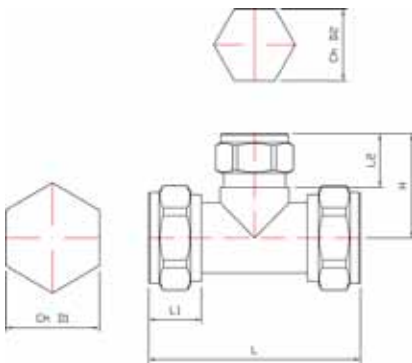

Size mm	L	H	L1	L2	L3	Ch D1	Ch D2	Ch D3	Code
12x15x12	59	30	17,5	15	17,5	19	24	19	84.01.928
15x12x12	59,5	29,5	15	17,5	17,5	24	19	19	84.01.938
15x15x12	59,5	30	15	15	17,5	24	24	19	94.01.948
15x12x15	60	29,5	15	17,5	15	24	19	24	94.01.958
15x22x15	62	35	17	18	17	24	32	24	84.02.018
22x15x15	62,5	33,5	18	17	17	32	24	24	84.02.118
22x22x15	70	36	18	18	17	32	24	24	84.02.218
22x15x22	56	35	18	17	18	32	24	32	84.02.318
28x22x22	74,5	39,5	20	18	18	38	32	24	84.03.968
28x28x22	81	41	20	20	18	38	38	32	84.03.988
28x15x28	70	38	20	17	20	38	24	38	84.03.618
28x22x28	77	40	20	18	20	38	32	38	84.03.718

84.01



REDUCING TEE C x C x C

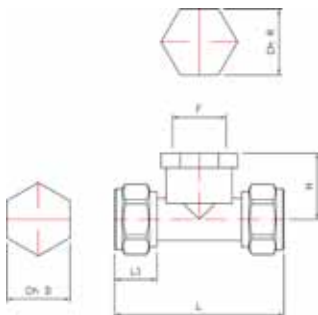

Size mm	L	H	L1	Ch D	F	Code
15 mm x 1/2" x 15 mm	63	22	15	24	1/2	84.04.005
22 mm x 1/2" x 22 mm	72	27,5	18	32	1/2	84.04.015
22 mm x 3/4" x 22 mm	79	29	18	32	3/4	84.04.010
28 mm x 1/2" x 28 mm	77	30,5	20	38	1/2	84.04.020

84.04



TEE C x F x C

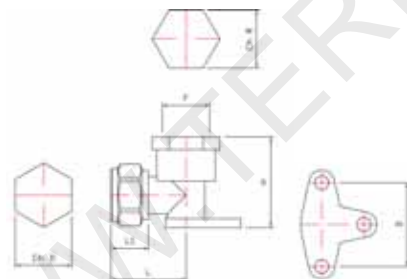

Size mm	L	H	L1	Ch D	Ch R	F	D	Code
15 mm x 1/2"	32	39	15	24	25	1/2	36	83.06.021
15 mm x 1/2" h.p.	32,5	45	15	24		1/2	34	83.06.121

83.06



WALL PLATE ELBOW

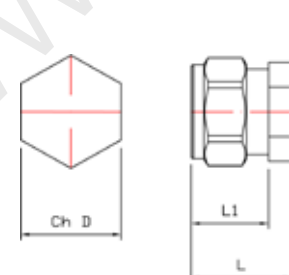

Size mm	L	L1	Ch D	Code
10	22,5	17,5	19	82.06.351
12	22,5	17,5	19	82.06.451
15	24	18,5	24	82.06.051
22	27	21,5	32	82.06.151
28	29,5	23	38	82.06.251

82.06



STOPEND

WWW.TERMAMARKET.COM.UA